

MSR-BTUK Magnetic Strip Reader & Keylogger With Bluetooth and USB Interface

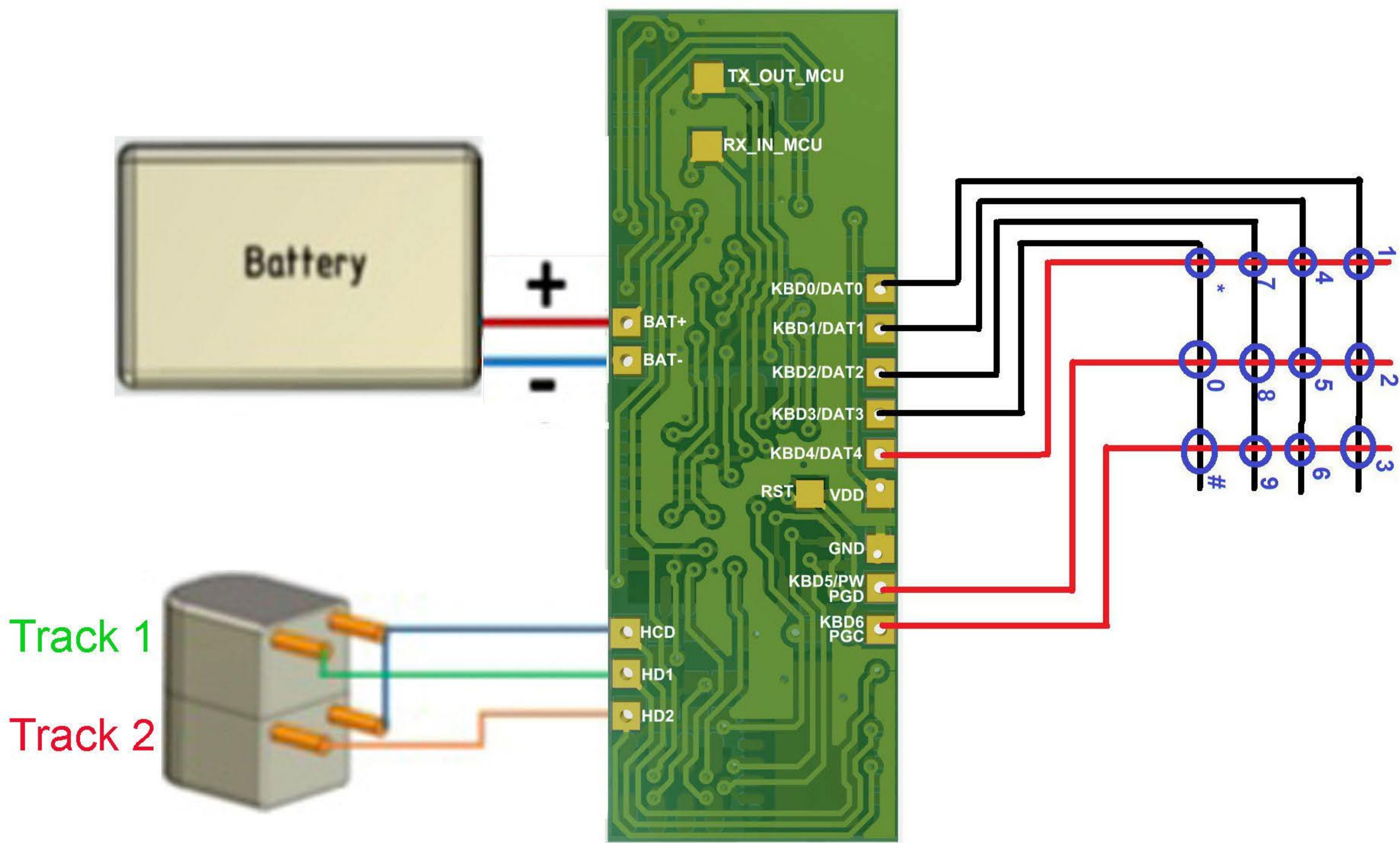

Install Android App "X-Term.apk"

1. Press On "Scan"
2. Press On Bluetooth Device

3. Press on "Wakeup"

4. Press on "Menu"

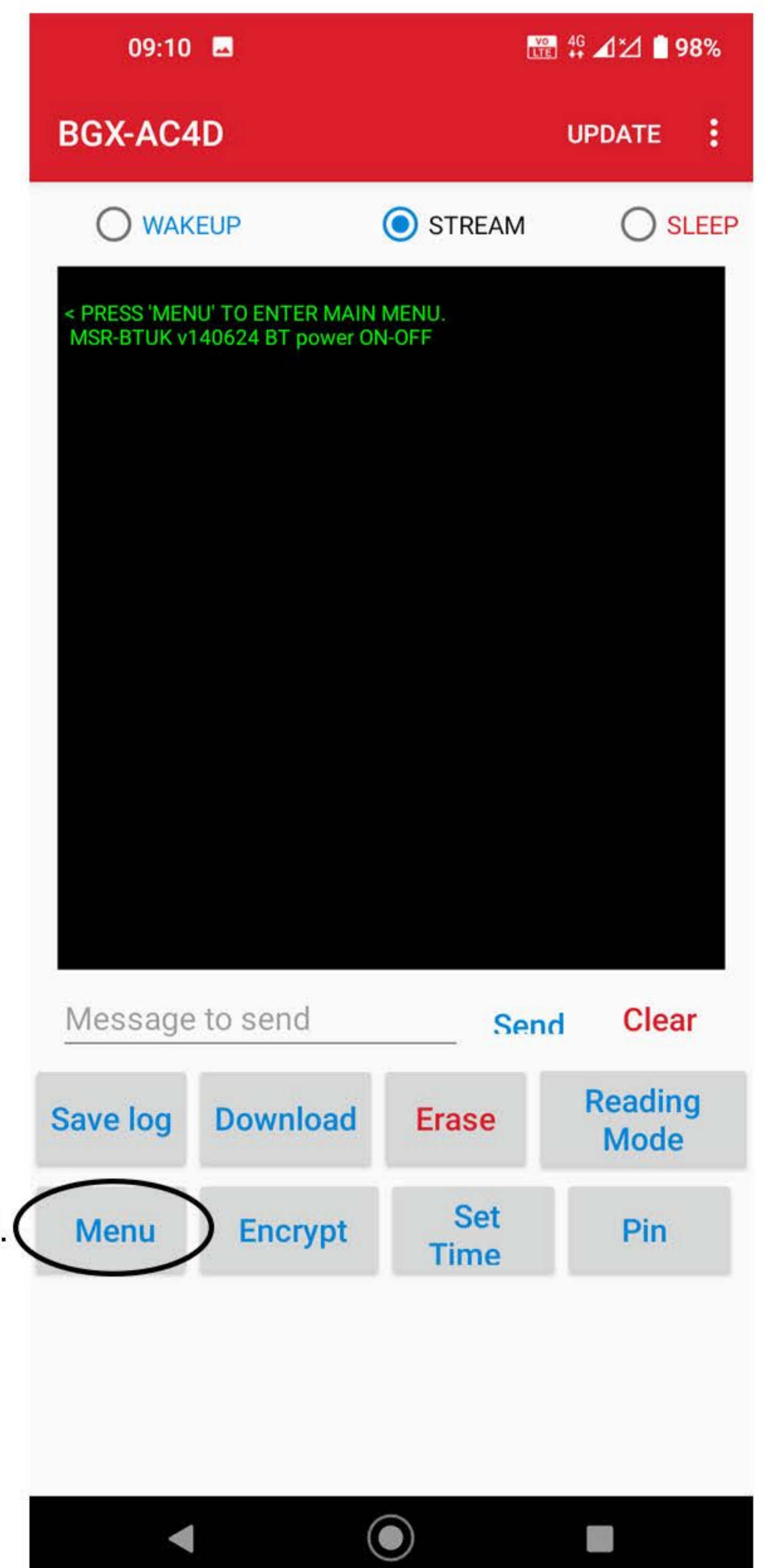
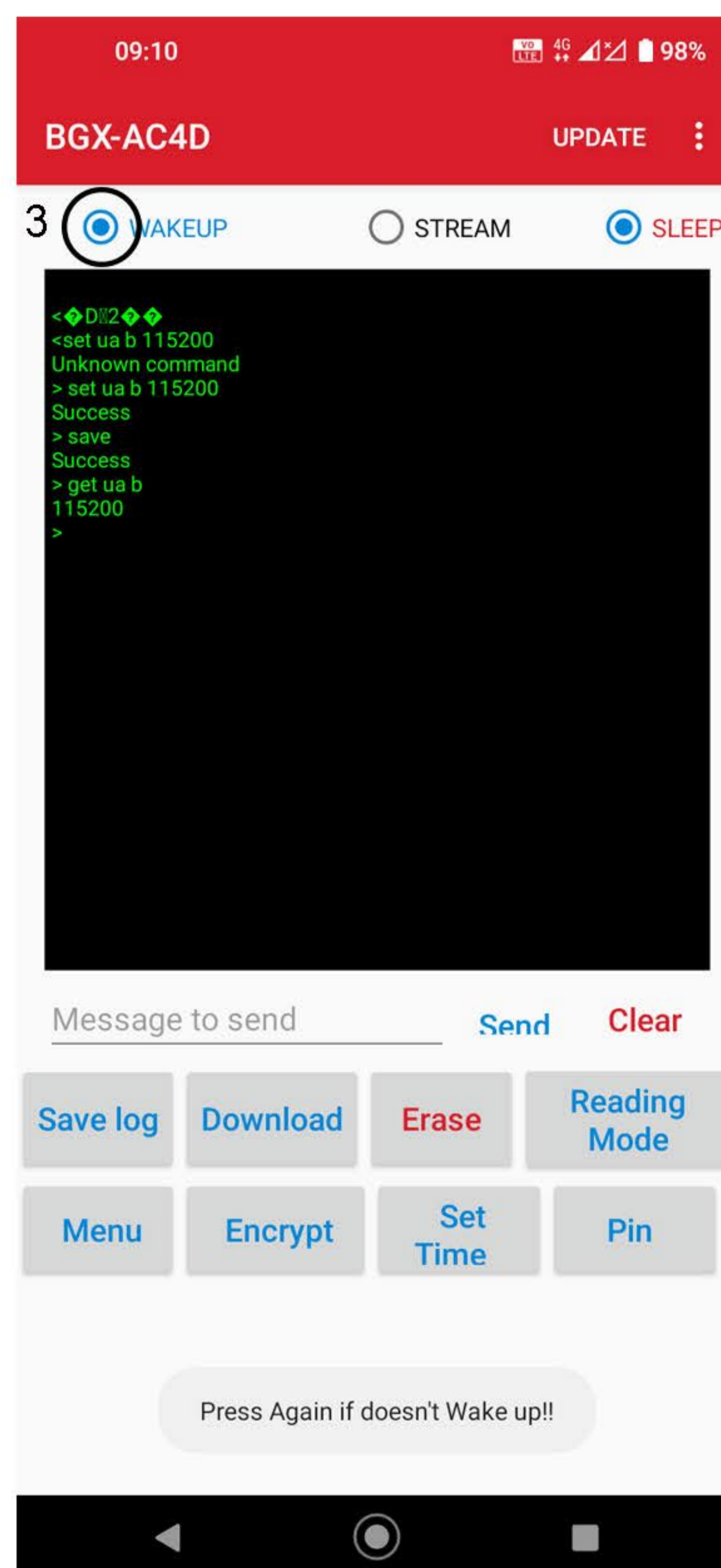
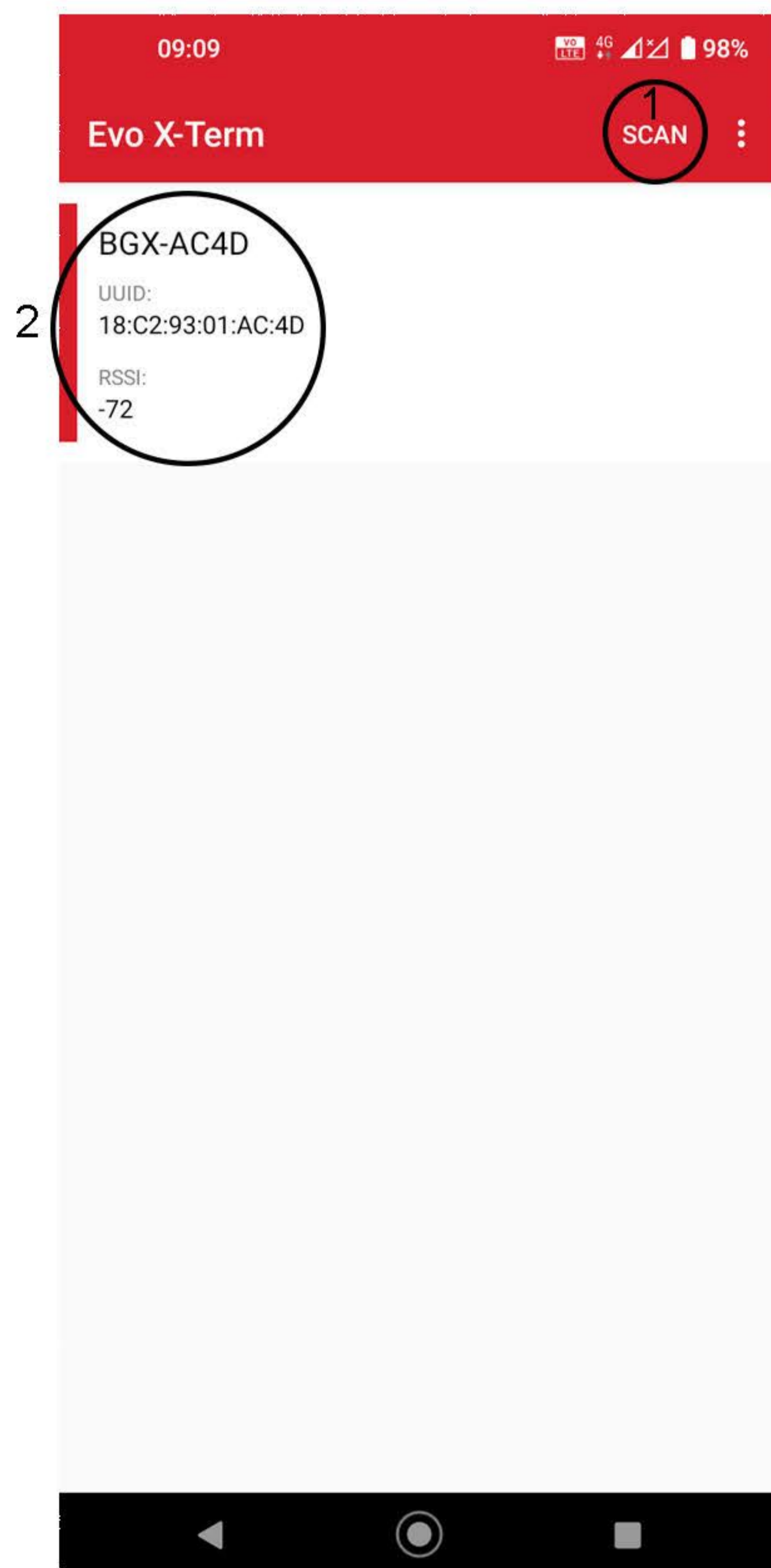

MSR-BTUK Magnetic Strip Reader & Keylogger With Bluetooth and USB Interface

⑤ Press "Time" and set time in following format:
YY-MM-DD-HH-MM
ex: *24-06-29-09-14* then press "send"

⑥ Press "Encrypt"
A menu will scroll asking to input encryption key as shown in picture 7

⑦ You must input exactly 10 caraters then press "send"
ex: 1234567890

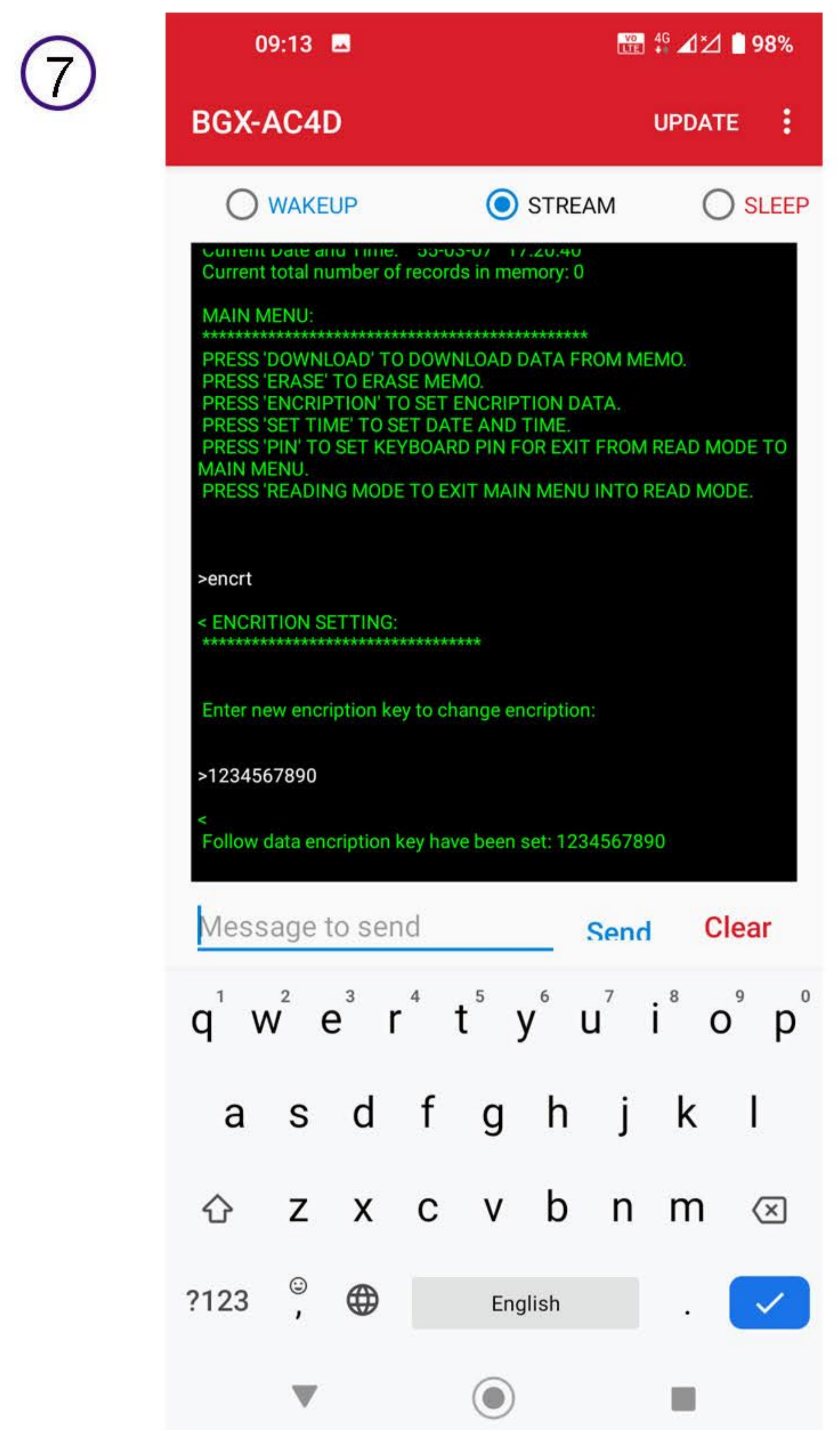
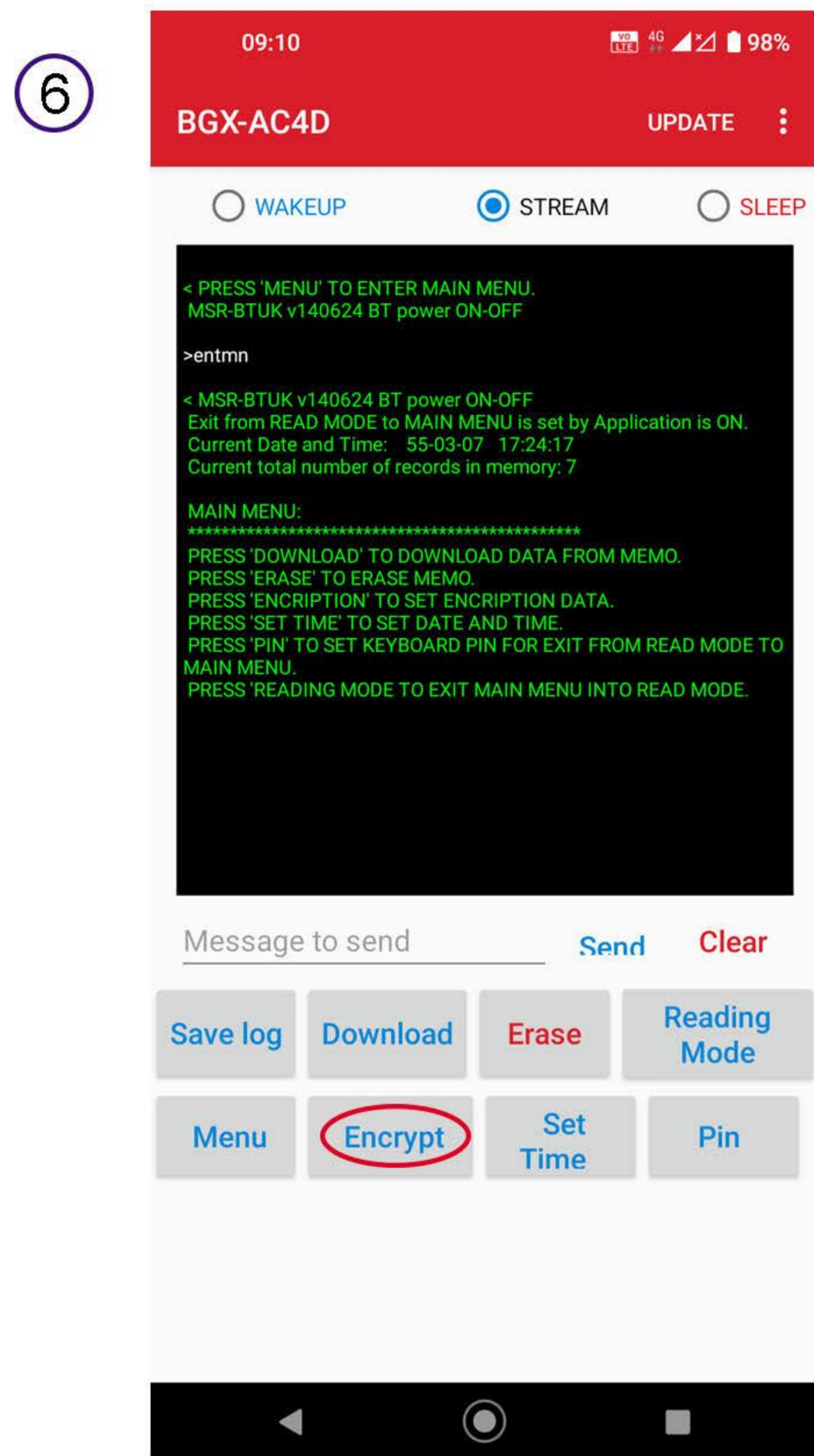
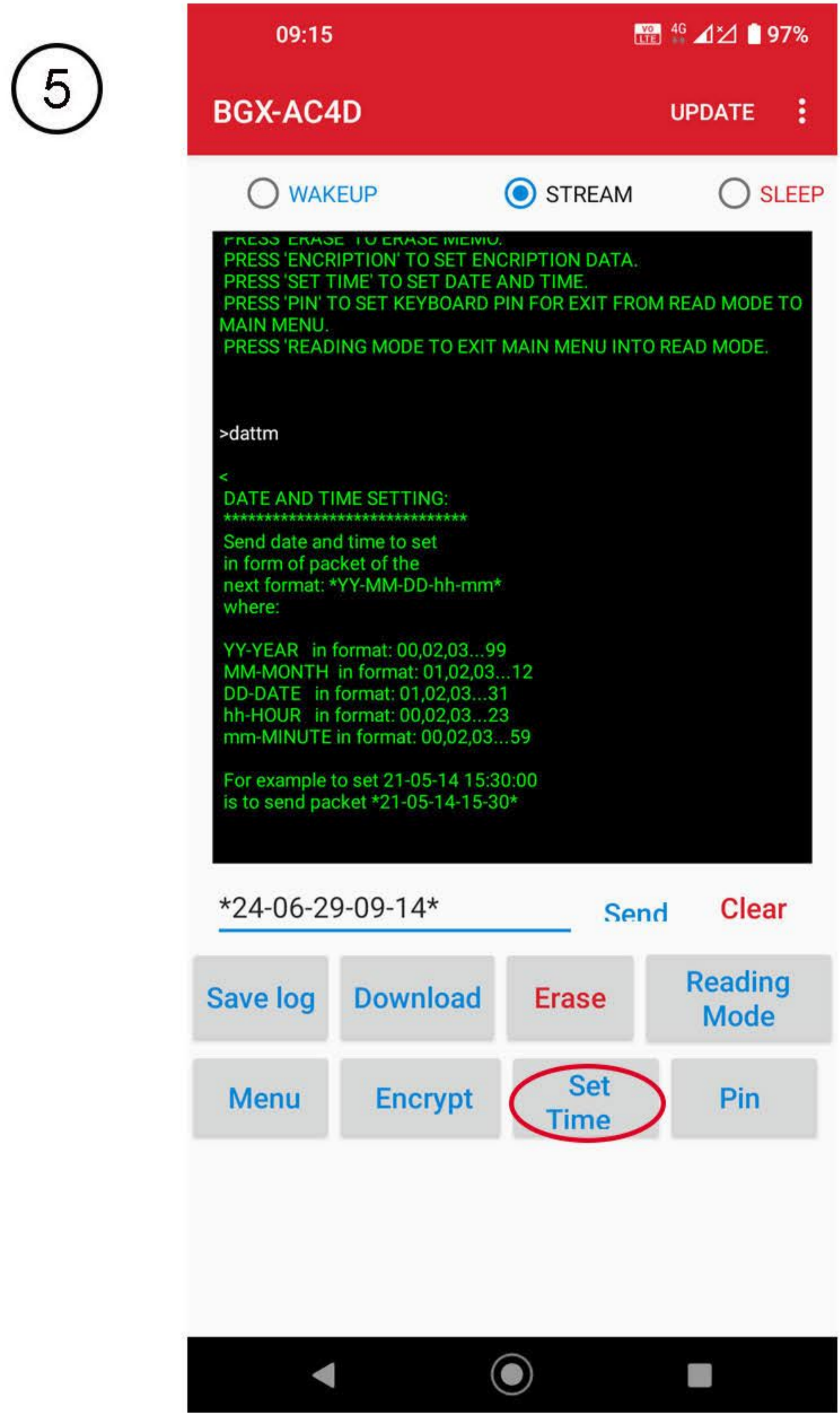

⑧ After Pressing "Menu" data count will show

⑨ Press "Download", "Enter Start Record" type in from which record you want to start Downloading, do not download more than 300 records per download

⑩ "Enter Last Record you want to download. if more than 300 records choose from 1-300 than download again from 301-600 etc ...

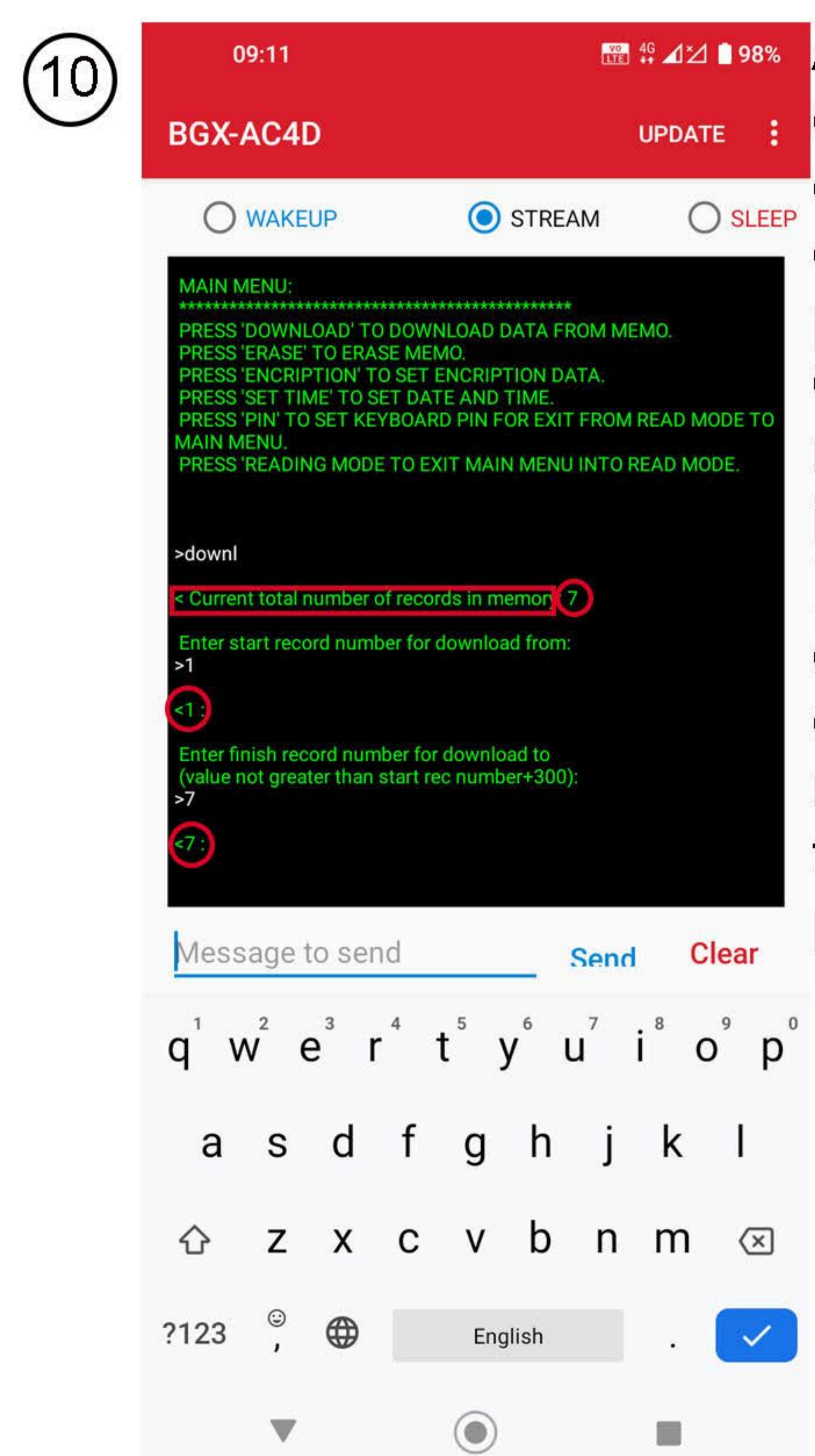
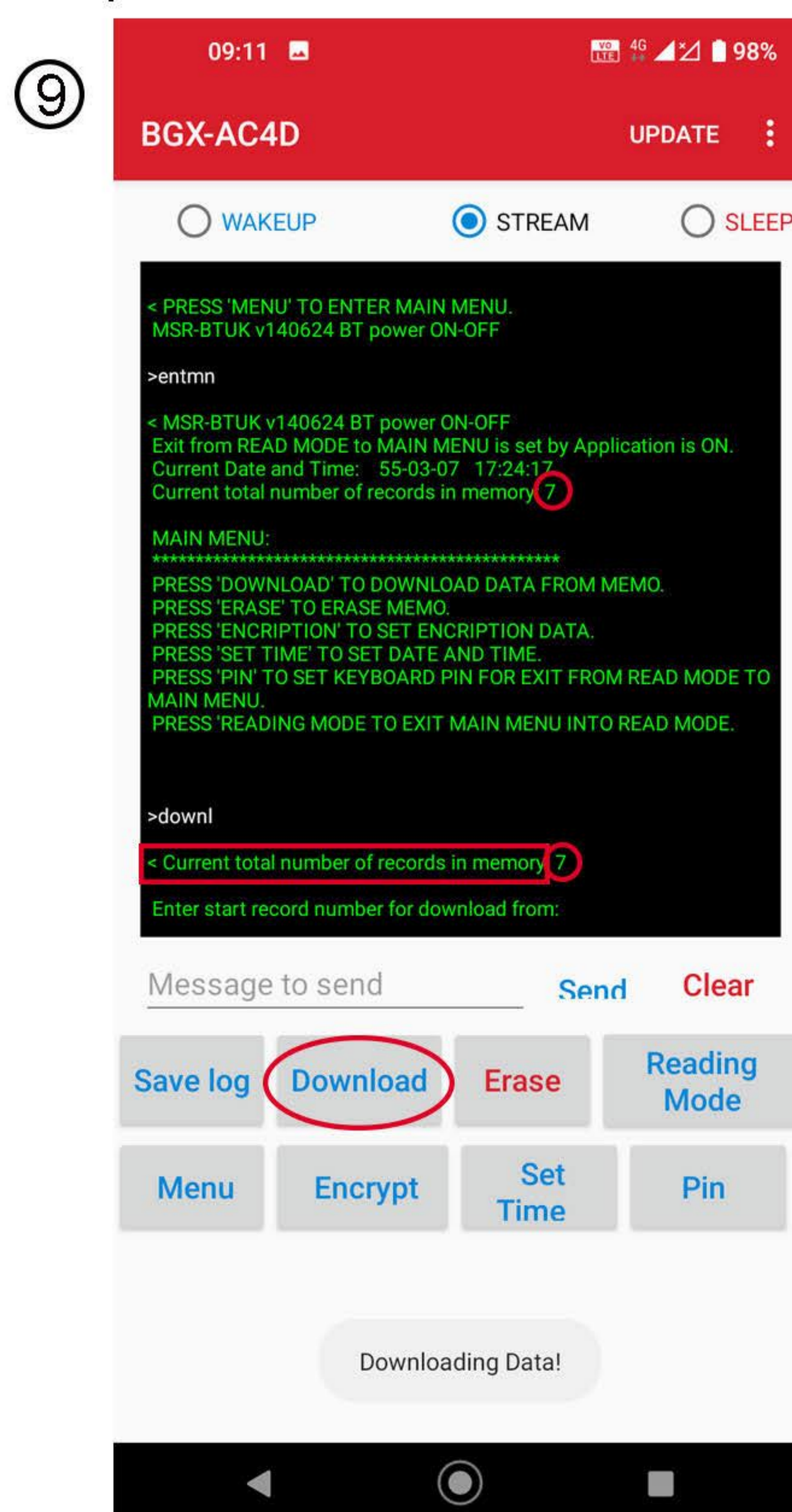
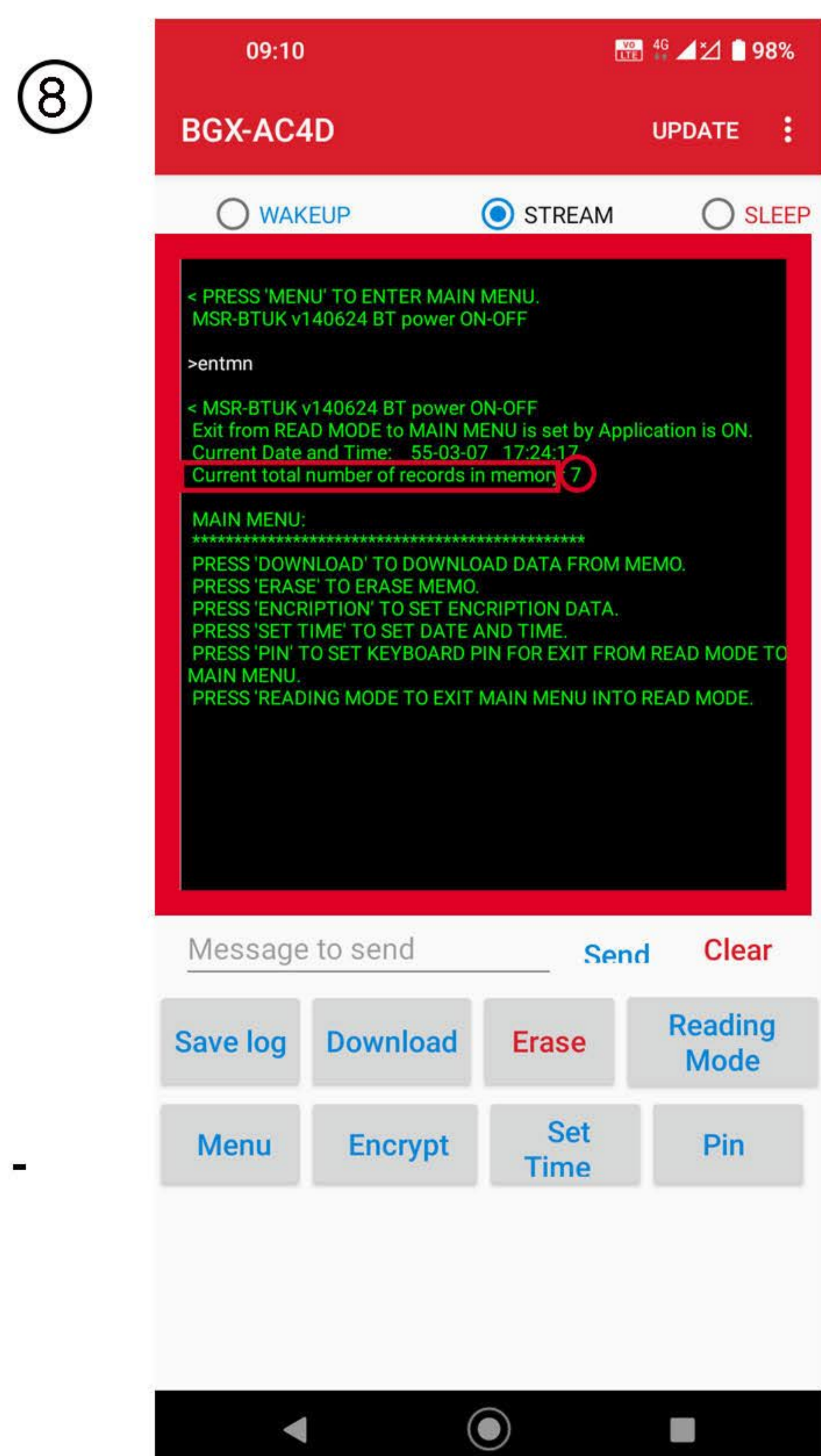

Amount of records depends of your phone Cache memory if 16GB RAM you can easily download more than 300 per time.

MSR-BTUK Magnetic Strip Reader & Keylogger With Bluetooth and USB Interface

⑪ After Downloading DO NOT forget press on "Save Log" or data will be lost if not save

⑫ File will be saved in phone Folder: /Internal Storage/Android/data/crt.evo_bluetooth_x_term/files/2024_06_29_12_52.txt (depending OF COURSE on the date and time the file name will change) to decrypt encrypted file you will need to copy it to you laptop and use DecoderV3.exe to decode.

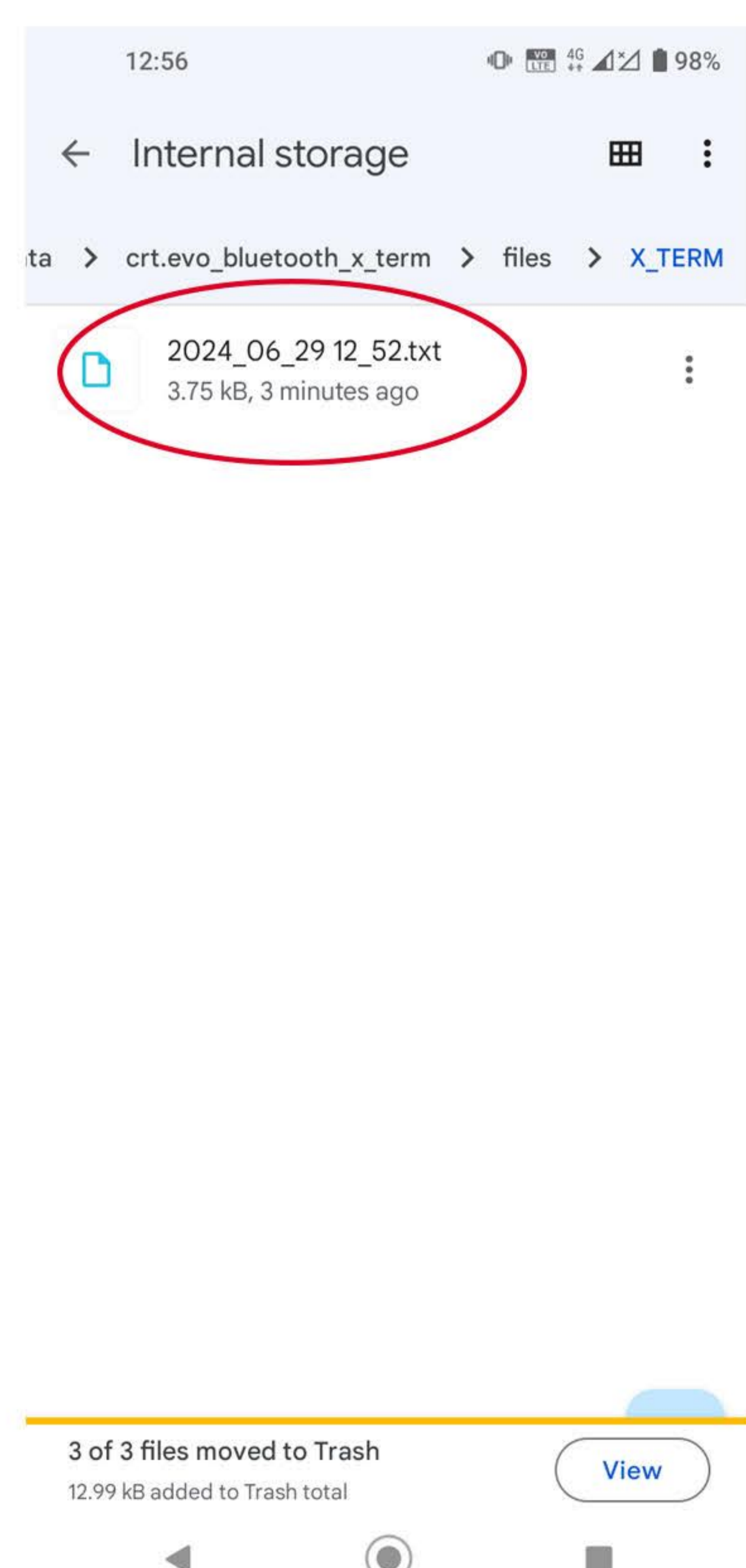
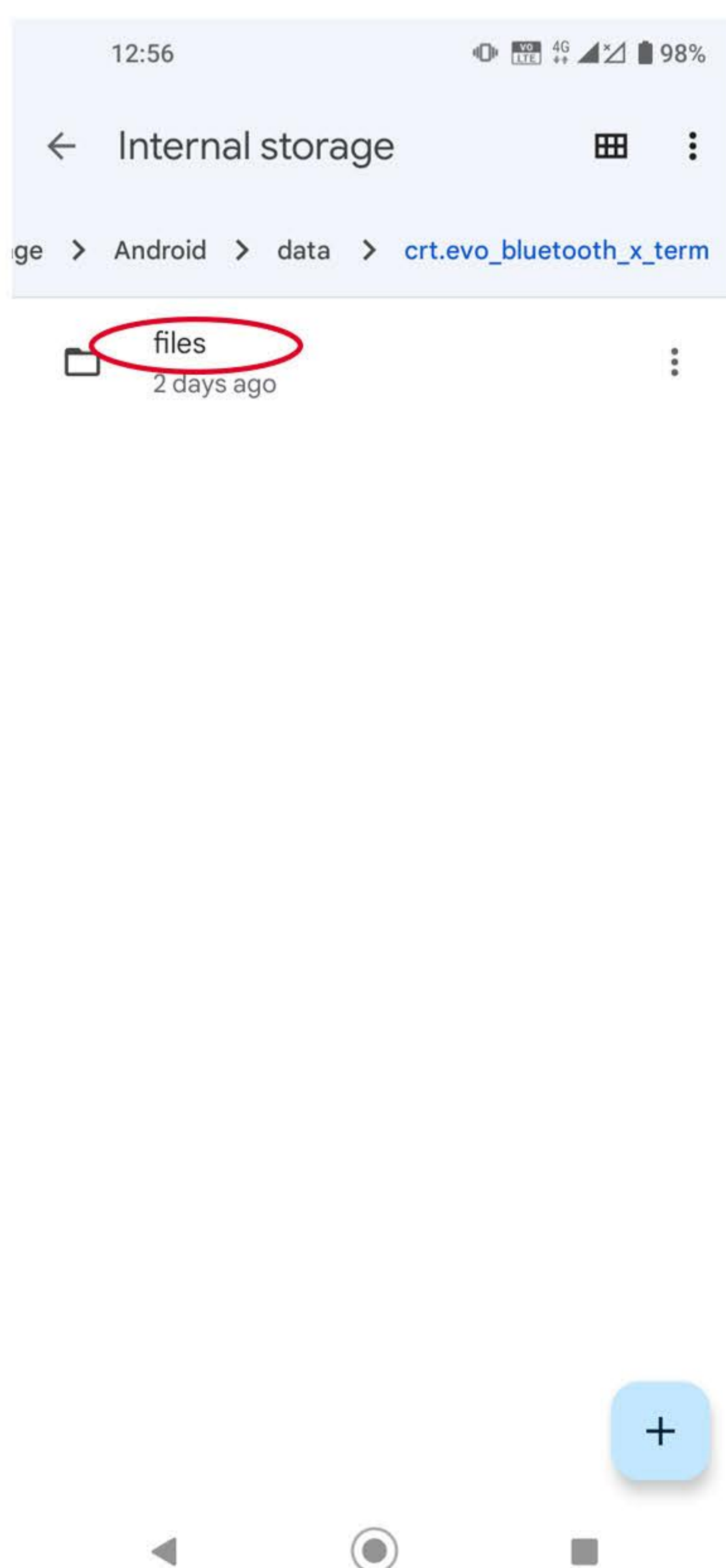
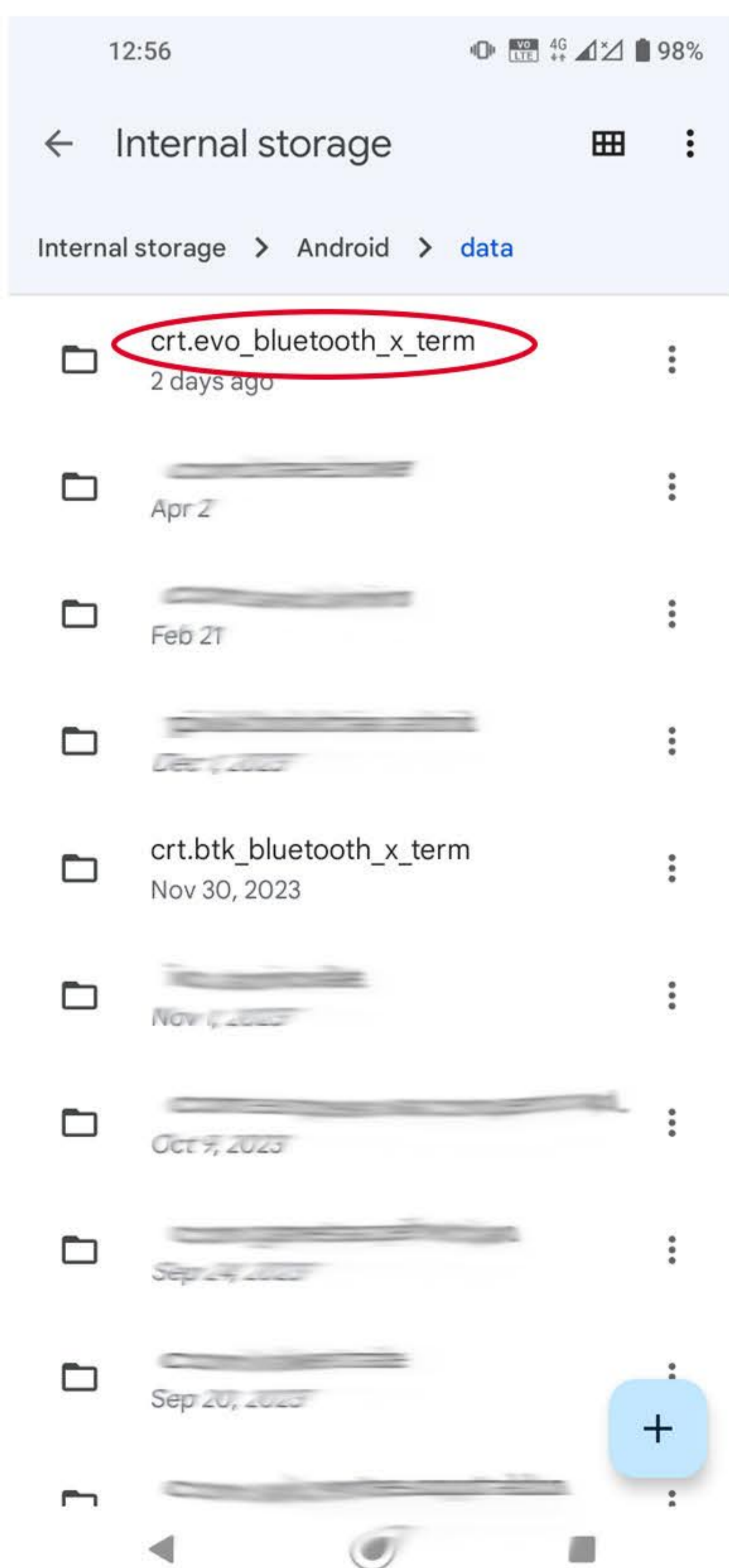
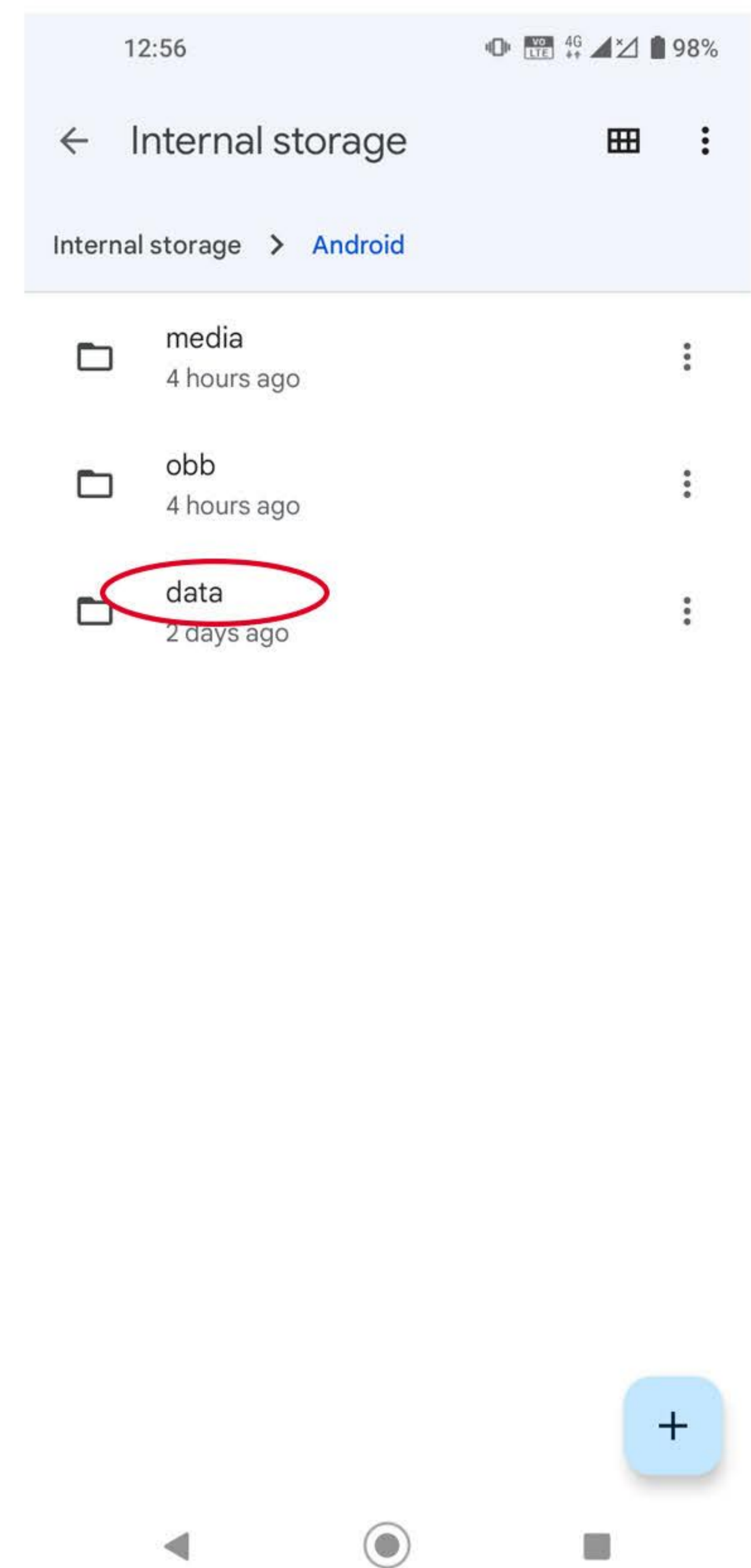
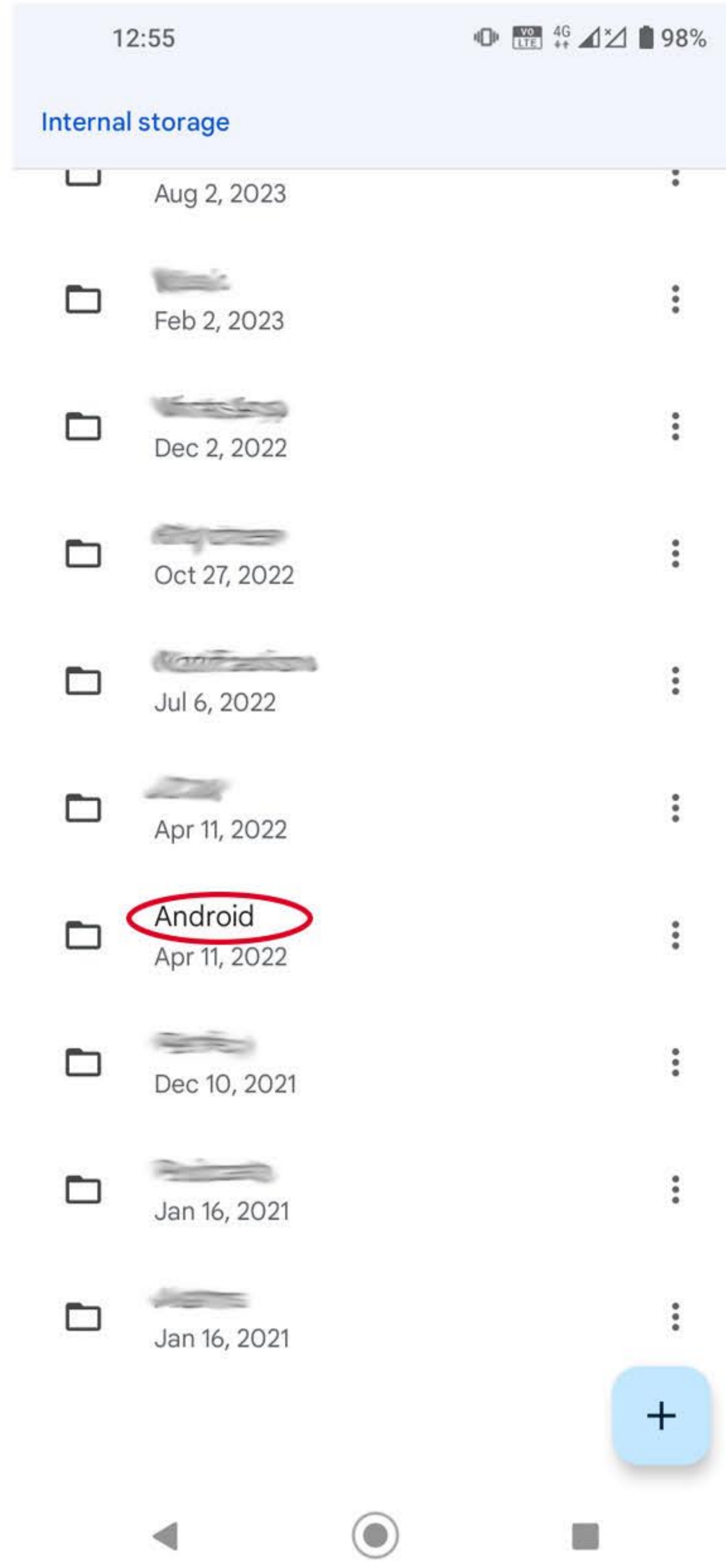
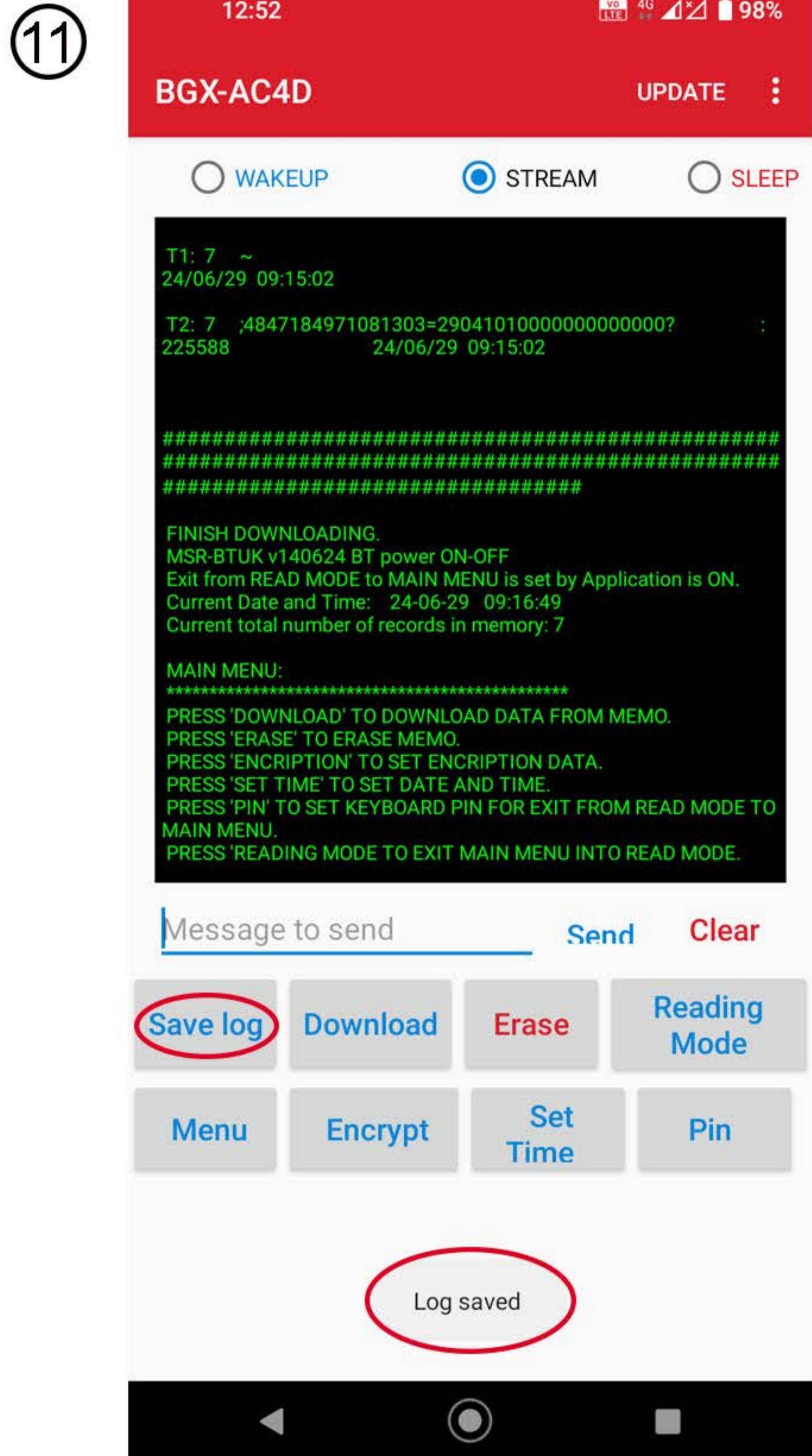

MSR-BTUK Magnetic Strip Reader & Keylogger With Bluetooth and USB Interface

13 Press "Pin" to set keypad input pin to activate Bluetooth if you decide to TURN OFF COMPLETELY Bluetooth. if this fonction activated Bluetooth will not be visible anymore untill this pin is entered on keypad

14 After "Pin" pressed a menu will show to enter 6 digit pin to activate Bluetooth ex: 123456

15 After file is saved you can now erase data by pressing "erase" once data is erase it is IMPOSSIBLE to recover it data is not kept in phone cache memo !!!!

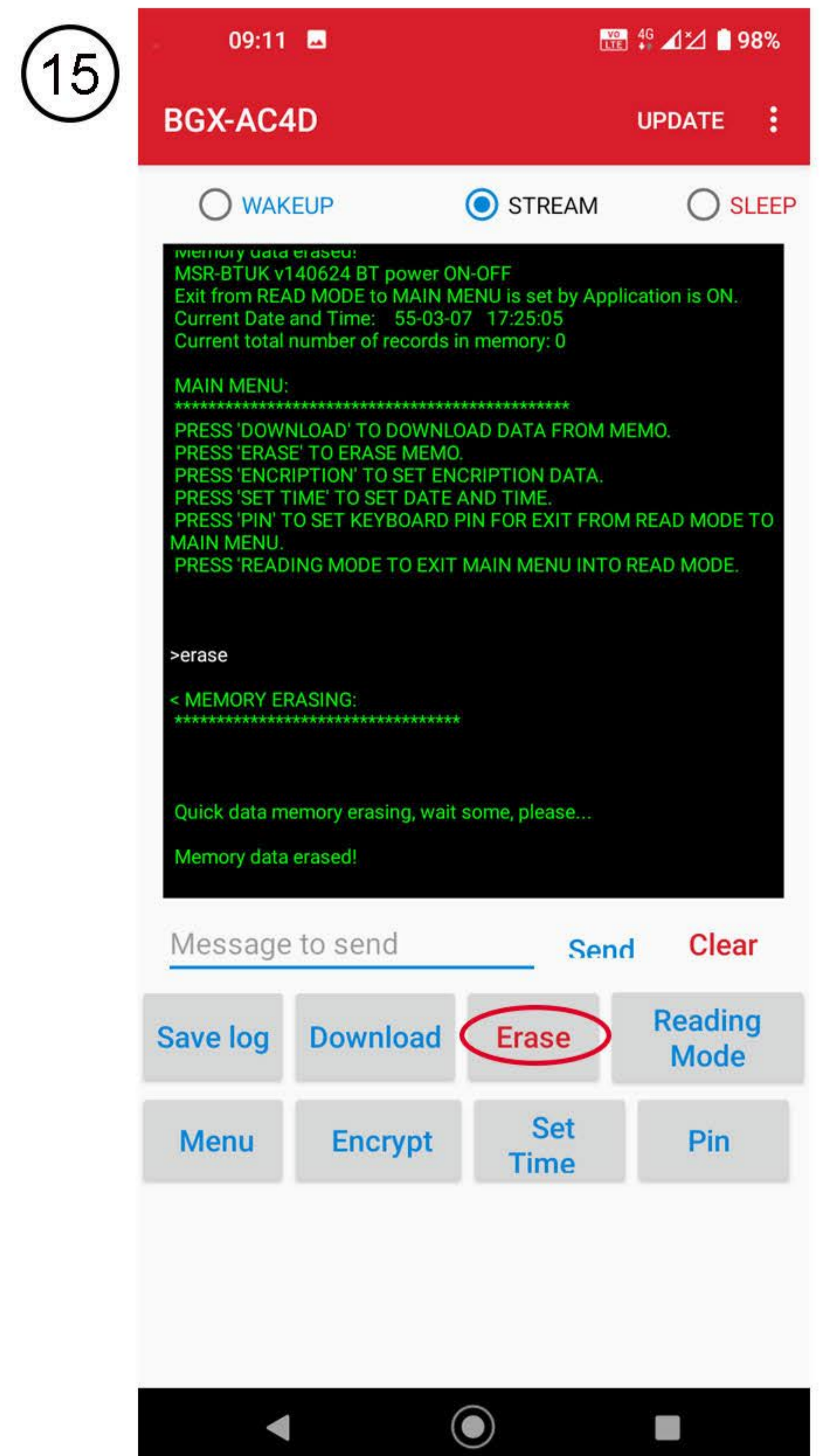
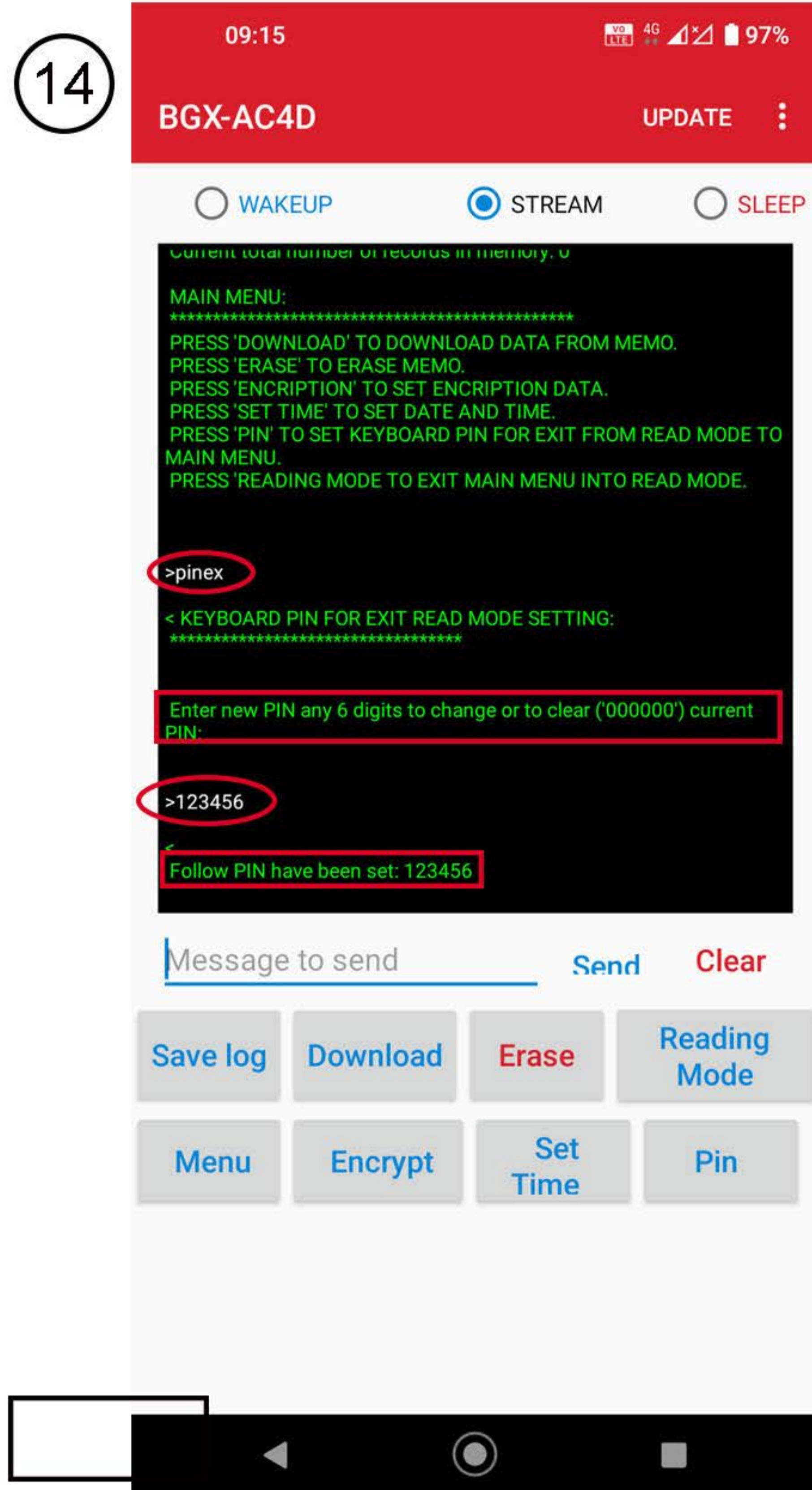
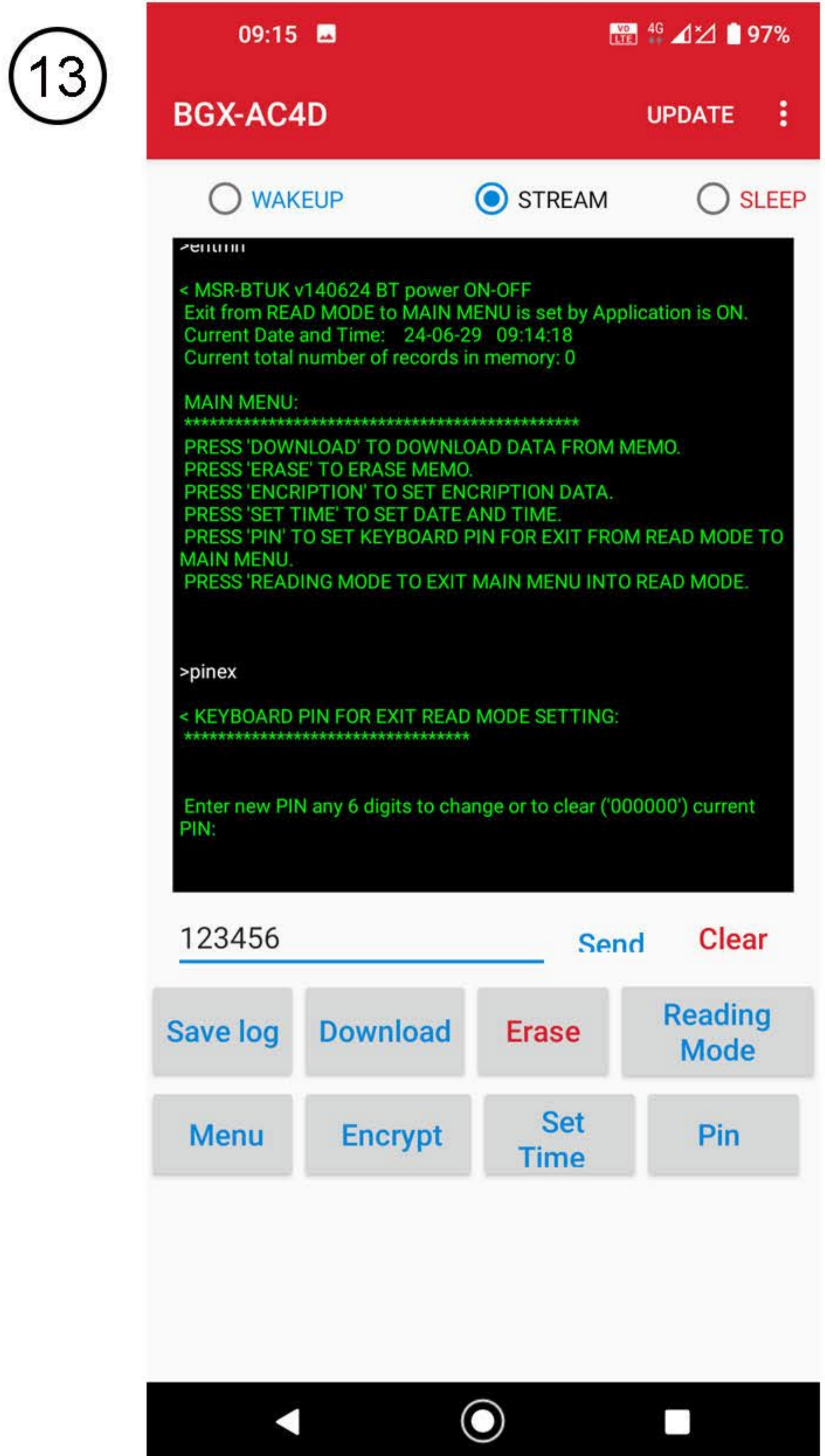

16 First Press "Reading Mode" then Press on 'SLEEP' to set device into deep sleep low power consumption mode. **IMPORTANT:** If you do not set device into "SLEEP" Mode device will consum 20 times more power and will kill battery very fast.

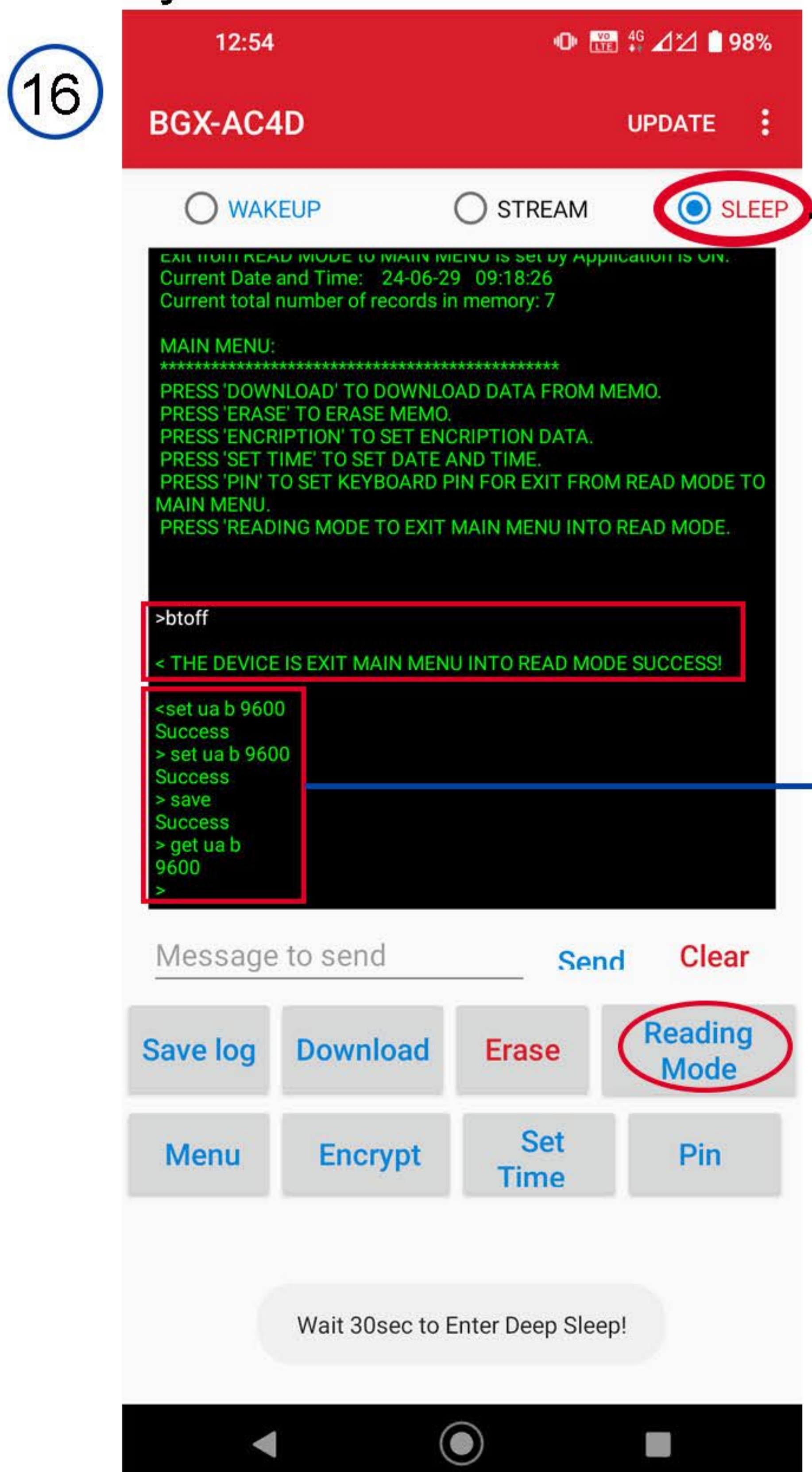

When this message appears "set ua b 9600" Success it means device has entered Deep Sleep successfully to access menu again you must WAKEUP device when entering menu after each manipulation, you MUST reenter SLEEP mode again You must wait 30 seconds before device goes into Reading mode after closing app, if using "PIN" Fonction this sleep mode is not necessary since Bluetooth is completely off in this mode. Sleep fonction is only to reduce Bluetooth Always On fonction.